

HDL series - Gripper (Wide type)

Operation specification and Ordering expression

CHELIC PNEUMATIC

Internal structure

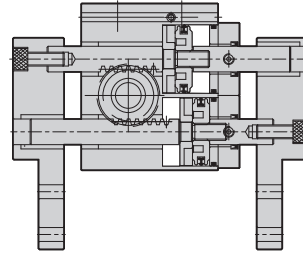

Specification

Item	Model	HDL - 20	HDL - 32
Bore size		20	32
Type of operation		Double acting	
Fluid		Air	
Pressure range	kgf/cm ² (kpa)	2 ~ 7 (200 ~ 700)	
Range of service temperature	°C	5 ~ 60	
Max. operation pressure	kgf/cm ² (kpa)	10 (1000)	
Theoretical gripping Torque (M)	Kgf-cm ² Closed side	3	10
Max. moment arm (L)	mm	50	70
Lever closes stroke	mm	14	16
Port size		M5 X 0.8P	

Note1 : L : The length of gripping points = 30mm · M : Theoretical gripping Torque · P : Operated pressure = 5Kgf/cm²

How to order

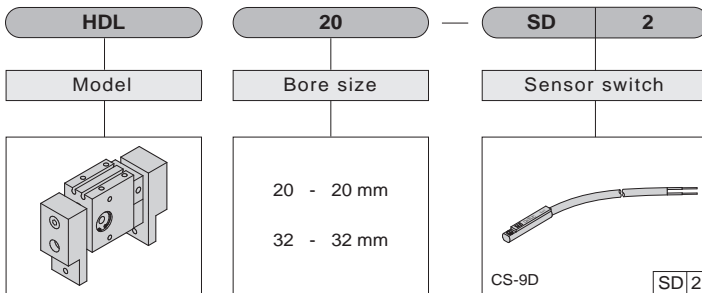

HDL : Gripper

Length of gripping point

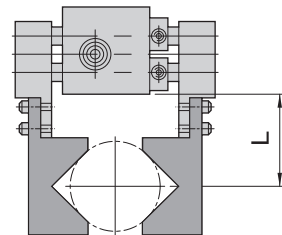

None : Without sensor switch

SD : Sensor switch code (CS-9D)

SB : Sensor switch code (CS-9B)

SH : Sensor switch code (CS-9H)

SDN : Sensor switch code (CS-9DN)

SDP : Sensor switch code (CS-9DP)

SG : Sensor switch code (CS-8G)

SGN : Sensor switch code (CS-8GN)

SGP : Sensor switch code (CS-8GP)

* CS-9H use for voltage AC / DC 5 ~ 240V

2 : Number of sensor switch

1 = 1 PCS

2 = 2 PCS

HDS
Angular
Gripper

HDM
180°Angular
Gripper

HDP
Parallel
Gripper

HDF
Parallel
Gripper

HDZ
Parallel
Gripper

HDZL
Parallel
Gripper

HDW
Parallel
Gripper

HDL
Gripper

HDT
Gripper

HDR
Gripper

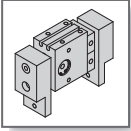

HDL series - Gripper (Wide type)

Components and Material list gripping force characteristic **CHELIC PNEUMATIC**

Internal structure

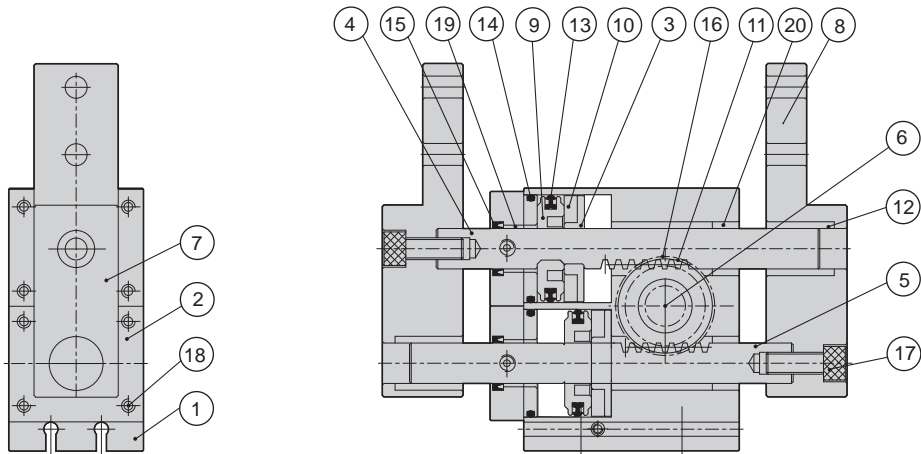

Components and Material list

No.	Item	Material	No.	Item	Material
01	Body	Aluminum alloy	11	Bearing	Bearing steel
02	Side cover	Aluminum alloy	12	Bushings	Teflon
03	Magnet cover	Aluminum alloy	13	Piston packing	NBR
04	Piston rod	Middle Carbon steel	14	Side cover O-Ring	NBR
05	Piston rod	Middle Carbon steel	15	Rod packing	NBR
06	Gear rod	Middle Carbon steel	16	Snap ring	Spring steel
07	Right lever	Aluminum alloy	17	Screw	Alloy steel
08	Left lever	Aluminum alloy	18	Screw	Alloy steel
09	Piston	Aluminum alloy	19	Bushings	Teflon
10	Magnet	Rubber	20	Bushings	Copper

Packing and O-Ring

Item	End cover o-ring	Piston packing	Rod packing
Bore size mm	Number	2	2
Ø20	COP-20	DYR-10	Ø15.5X Ø1.45
Ø32	COP-32	DYR-12	Ø28.5X Ø2.0

Weight

Model	Weight Kg
HDL - 20	0.4
HDL - 32	1.1

Gripping force characteristic

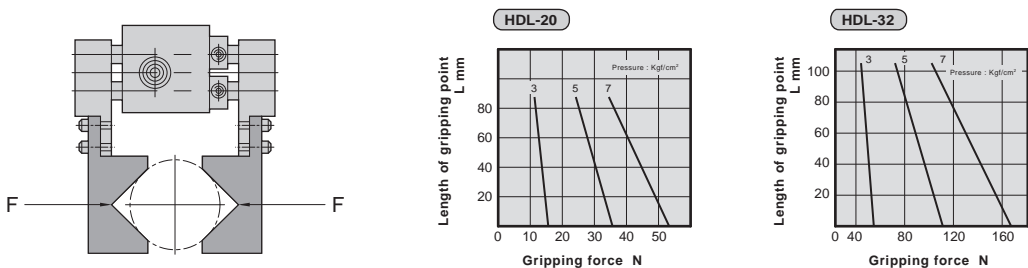

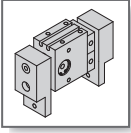

HDL series - Gripper (Wide type)

External dimension and Mounting type

CHELIC PNEUMATIC

☛ Mounting type (2 types)

☛ Side mounting type

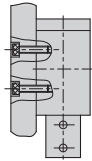

☛ Sensor switch installation

☛ Position of mounting sensor switch

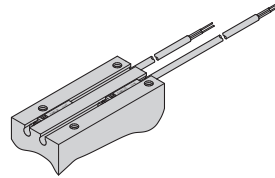

☛ Top side mounting type

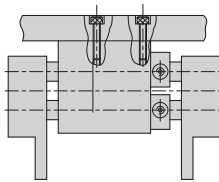

☛ Mounting type of sensor switch

CS-9D(B)
(Please refer P.6-2.15
sensor switch standard)

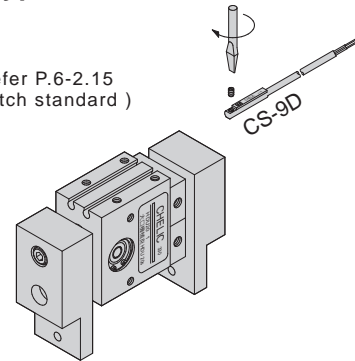

☛ External dimension

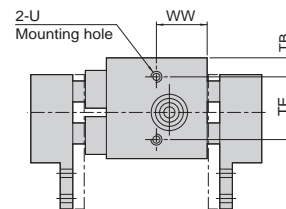
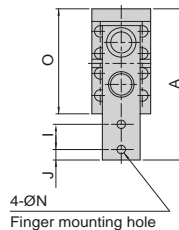
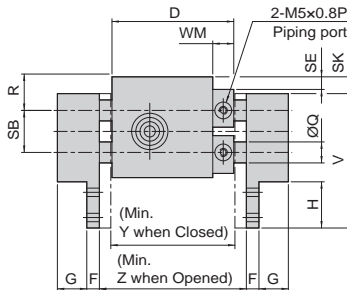
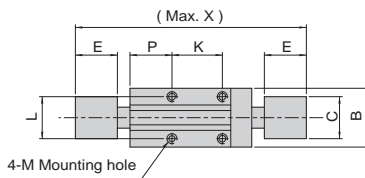

Code Model	A	B	C	D	E	F	G	H	I	J	K	L	M
HDL - 20	76	30	20	55	20	8	12	24	12	6	25	20	M4X0.7P dp 6
HDL - 32	115	40	25	74	24	12	12	42	20	7	30	30	M5X0.8P dp 8

Code Model	N	O	P	Q	R	SB	SE	SK	TB	TE	U	V	WM	WW	X	Y	Z
HDL - 20	4.5	50	15	10	16.5	22	5.5	8	9.5	36	M4X0.7P	68	10	19	109	55	69
HDL - 32	6.5	78	17	12	26	34	9	16	13	60	M6X1.0P	99	10	32	138	74	90

HDS
Angular
Gripper

HDM
180°Angular
Gripper

HDP
Parallel
Gripper

HDF
Parallel
Gripper

HDZ
Parallel
Gripper

HDZL
Parallel
Gripper

HDW
Parallel
Gripper

HDL
Gripper

HDT
Gripper

HDR
Gripper